

INSTRUCTION MANUAL

FieldLogger with 128k Memory



INSTRUCTION MANUAL

FieldLogger with 128k Memory



Table of Contents

1.	FOREWORD.....	3
2.	GENERAL INFORMATION	3
3.	SYMBOLS EMPLOYED	3
4.	SAFETY INSTRUCTIONS.....	4
5.	INTENDED USE	4
6.	DISPOSAL.....	5
7.	SCOPE OF DELIVERY	5
8.	DEVICE DESCRIPTION	5
9.	INSTALLATION.....	6
10.	OPERATION.....	15
11.	TECHNICAL DATA	23
12.	GENERAL QUESTIONS	24

INSTRUCTION MANUAL

FieldLogger with 128k Memory



1. FOREWORD

Dear customer,

We thank you for having purchased the FieldLogger Register and are very glad that you decided for a product of **B+B Thermo-Technik GmbH**. We hope this product will fully satisfy you and will assist you effectively in your work.

This device has been developed to be technically highly up-to date. This product has been designed in accordance with the regnant European and German national directives and rules. For a proper and effective usage of the product the customer shall observe the following Operating Instructions. In the case that against one's expectations any trouble occurs which you can not resolve yourself, please contact our service centers or our authorized dealer. We will provide you rapid and competent help to minimize the risk of long time outfalls.



The following operating instruction is an indispensable part of this Product. It contains important advices for the starting up and further use of the device.

2. GENERAL INFORMATION

This Operation Manual is intended to serve as an aid in the proper setup, installation and operating of the FieldLogger Register. All essential details of the equipment and all actions required on the part are clearly presented and explained. We thus ask that you read this manual carefully before proceeding to work with the equipment. Keep this manual available for ready reference in a convenient and conspicuous location near the equipment.

3. SYMBOLS EMPLOYED

Sign	Meaning	Notice
	Advice	It is necessary to read the following advices before using the product. The used symbols in the manual acts first of all as eye catcher for security risks. The symbols do not replace the security advices. The text must be read completely.
	Necessarily to observe	This symbol designates important advices and tips which are necessary for the success of a procedure. They have to be followed in order to get good results.

INSTRUCTION MANUAL

FieldLogger with 128k Memory



Warning Signs	Meaning	Warning Signs	Meaning
	This symbol advises the user of danger for persons, material or environment. The text gives information that must be necessarily followed to avoid any risks		Caution against electromagnetic fields (BGV A8, GUV-V A8/W12)
	Caution against hot surfaces (BGV A8, GUV-V A8/W26) and hot liquids or substances		Caution against severe cold (BGV A8, GUV-V A8/W17)
	Caution against liquids and hot substances		Caution against dangerous high electrical voltage (BGV A8, GUV-V A8/W08)
	Caution against dangerous explosive substances (BGV A8, GUV-V A8/W02)		Caution against dangerous explosive atmosphere (BGV A8, GUV-V A8/W21)
	Caution against moving machines (W29) Caution against moving parts		Electronic waste

4. SAFETY INSTRUCTIONS

B+B Thermo-Technik GmbH assume no liability for damages occurred through failure to observe these security advices. A usage none conform to the instructions given in this manual can damage the device

The use of the measurement system must be restricted to qualified personal.



The system is not adequate for use in atmosphere with explosion risk.



Do not use the system in a high electric or magnetic field area.

Test this equipment prior to each use.



The system must be operated only within the limits given in the technical Data
Exposing the system to hot temperatures (higher than the operating temperature) will cause damages in the electronic circuits and also damage the housing.

5. INTENDED USE

The use of the unit in fields other than those indicated under "SAFETY INSTRUCTIONS" is not allowed for safety reasons.

This instruction manual does not at all substitute any additional instruction manual of connected accessories.



INSTRUCTION MANUAL

FieldLogger with 128k Memory



6. DISPOSAL



This unit has been marked in accordance with the European Directive 2002/96/EC on waste electrical and electronic equipment (WEEE).

At the end of its useful operating life, dispose of the unit as electrical scrap.

Please ask either B+B Thermo-Technik GmbH or your specialist dealer for information on your local collection point. Within the scope of application of this Directive, B+B Thermo-Technik GmbH is responsible for proper disposal of this unit.

7. SCOPE OF DELIVERY

1 x FieldLogger Register
1 x Operating Manual
1 x FieldLogger Software

8. DEVICE DESCRIPTION

FieldLogger is an equipment that reads and registers analogue variables. It works as an **electronic data logger**, storing logged information in its internal memory for later analysis. It can also work as a real-time remote measuring module, which does not have internal memory and only logs information and transmits them to a supervisory system. Its 8 configurable input channels, digital input and alarm outputs, backup power, etc, make it very versatile, which makes possible to use it in a large number of applications. It is configured through an easy-to-use software. The equipment is provided with the software, which runs on Windows98 platform and higher.



INSTRUCTION MANUAL

FieldLogger with 128k Memory



9. INSTALLATION

9.1 INPUT

The logger has 8 input channels. You can configure the type of signal to be read by each channel. All types of input channels accepted are factory calibrated and no further adjustment is required. The user defines and configures the channels that will be in use, and disables the others.

The types of input channels accepted by the logger and their maximum ranges are listed in Table 01.

INPUT TYPE	MEASUREMENT RANGE
Thermocouple J	-50.0 to 760.0°C (-58.0 to 1400.0°F)
Thermocouple K	-90.0 to 1370.0°C (-130.0 to 2498.0°F)
Thermocouple T	-100.0 to 400.0°C (-148.0 to 752.0°F)
Thermocouple E	-35.0 to 720.0°C (-31.0 to 1328.0°F)
Thermocouple N	-90.0 to 1300.0°C (-130.0 to 2372.0°F)
Thermocouple R	0.0 to 1760.0°C (-32.0 to 3200.0°F)
Thermocouple S	0.0 to 1760.0°C (-32.0 to 3200.0°F)
Thermocouple B	150.0 to 1820.0°C (302.0 to 3308.0°F)
Pt100	-200.0 to 530.0°C (-328.0 to 986.0°F)
4 – 20 mA Lin. J	Thermocouple J curve, -50.0 to 760.0°C
4 – 20 mA Lin. K	Thermocouple K curve, -90.0 to 1370.0°C
4 – 20 mA Lin. T	Thermocouple T curve, -100.0 to 400.0°C
4 – 20 mA Lin. E	Thermocouple E curve, -35.0 to 720.0°C
4 – 20 mA Lin. N	Thermocouple N curve, -90.0 to 1300.0°C
4 – 20 mA Lin. R	Thermocouple R curve, 0.0 to 1760.0°C
4 – 20 mA Lin. S	Thermocouple S curve, 0.0 to 1760.0°C
4 – 20 mA Lin. B	Thermocouple B curve, 150.0 to 1820.0°C
4 – 20 mA Lin. Pt100	Pt100 curve, -200.0 to 530.0°C
4 – 20 mA Linear	Programmable indication range from -1999 to 9999
0 – 50 mV Linear	Programmable indication range from -1999 to 9999

MEASUREMENT INTERVAL

The speed of input channels readings depends on the number of channels enabled and type of input programmed for each channel. Each channel requires a reading time of about 50 ms. Programmed channels with Pt100 input need more than 50 ms for cable length compensation calculations. 150 ms are required for internal processing, regardless of the number of channels enabled. Thus, if only one channel is enabled, readings will take place at every 200 ms (50 + 150). If this channel is programmed to Pt100, 250 ms are required between readings (50 + 50 + 150). Required time to read the eight channels is 550 ms. If they are configured as Pt100 input, required time will be 950 ms.

9.2 OUTPUT

The logger has two relay outputs (**ALM1** and **ALM2**) that can work as **Alarm** or **Digital Output**.

When configured as Alarm, they act as configured by the user.

As Digital Outputs they are remotely controlled through serial communication.

INSTRUCTION MANUAL

FieldLogger with 128k Memory



9.3 ALARMS

The logger has two alarms (Alarm 1 and Alarm 2) that work independently. Each alarm has a setpoint that defines the triggering point. They can act as **Low** alarm or **High** alarm.

Low alarms are triggered (turn on an output) when the value read by the input channel is below the setpoint value. The **High** alarm is triggered when the value measured is above the setpoint value.

Alarm outputs can be associated to **ALM1** (relay 1) and **ALM2** (relay 2). The same alarm can be associated to both outputs. Such settings must be defined for each of the eight input channels.

9.4 SETUP

It is necessary to configure the logger before starting operation. It is necessary to define the working mode assigning values to a series of parameters. The register is provided with the **Configurator** software. It provides the parameters that define how the logger will work.

The software is supplied on CD. The installation on the user's PC is performed through the *FL_Setup.exe* application.

MINIMUM REQUIREMENTS

To obtain a good performance of the Configurator software, the PC must support the following requirements:

- Pentium III (or equivalent) or higher.
- Windows 98® or higher.
- A free serial port to support the communication with the register.

The system will perform better in computers with higher specifications. A RS485 (serial or USB) converter will be required.

INSTRUCTION MANUAL

FieldLogger with 128k Memory



RUNNING THE LOGGER

Before running the Configurator the logger must be connected to the computer. Use the free serial port, a RS232 / RS485 or USB / RS485 converter and suitable cables for the connection.

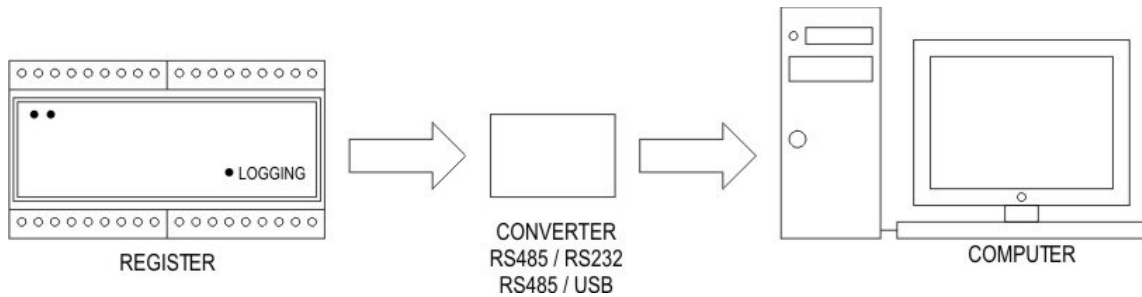

Figure 1 – Overview of the communication system

Note: The logger basic configuration is factory set (communication address 1, *baud rate 9600*, no parity, etc). **The first configuration must be accomplished in a point-to-point connection with the computer.** After it is configured with a specific communication address, among other parameters, it can be installed in a communication network together with other devices.

When you try to run the Configurator software there is an attempt of immediate communication with the connected logger. If communication is successful, the Configurator is fully loaded and the logger configuration is read and displayed. Settings are then allowed to be changed.

In case there is a communication fault, only the communication screen is loaded. It displays the communication parameters used in communication attempts. Selected serial port, baud rate, address and parity.

For a new communication attempt, the user must:

- Check connections;
- Check if the serial port displayed in the communication screen is the same as the selected one;
- Check if the serial port selected is really free in the computer;

After checking those items, press **Search** in the **Automatic Search** (valid only for a point-to-point connection). If communication is successful, the Configurator software is fully loaded.

USING THE LOGGER

When the logger and PC are connected, the Configurator is fully loaded. Four screens are available: **Communication**, **Channels**, **Acquisitions** and **Diagnostic**; which can be selected in the upper tabs.

CHANNELS SCREEN

In the channels selection screen, the user defines features for each channel, such as: input type, alarms, scale etc. Functions displayed are:

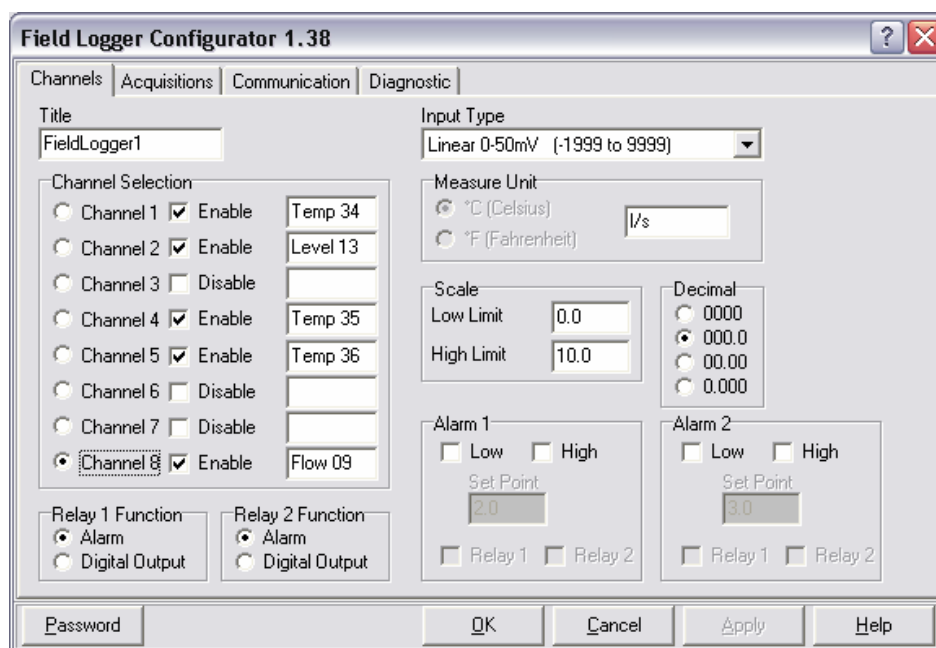

Figure 2 – Channels screen

Title – Defines a name for the logger (up to 16 characters).

Channel selection – Selects the channel to be configured. Information presented/defined in the remaining fields for this screen are related to the channel selected. Define channels that will remain active or enabled while the logger is operating in this field. It is also possible to assign names to the input channels (up to 8 characters).

Input Type – Defines the input type for the channel selected in Channel Selection. Options are displayed in Table 01.

Measurement Unit – Defines the measurement unit to be used. For temperature sensor input, options are °C or °F. For 4-20 mA and 0- 50 mV inputs it is possible to write the required unit.

Scale – For 4-20 mA and 0-50 mV input types it makes possible to make an indication scale, with the upper and lower indication limits. For the other input types, the logger use a preset scale.

Decimal – It defines the number of decimal points to be displayed in scales configured for channels with 4-20 mA and 0-50 mV inputs.

Decimal point – When the channel is configured as thermocouple, it is possible to choose how values will be displayed: with or without the decimal point.

ALM1/ALM2 – It makes possible to define if ALM1 and ALM2 will be used as Alarm or Digital Output. As Alarm, it is triggered as defined

in **Alarm 1** and **Alarm 2**. In Digital Output, triggering takes place only through serial communication commands (*Preset Single Coil*).

Alarm 1/Alarm 2 – After the alarm outputs are defined, the user defines alarm **Set Points** in these fields; as well as the working mode as Low or High. It also defines which output will be connected to the alarm.

The association between an output and alarms 1 and 2 is not required, but the alarm activities will be indicated in the *Holding Register 0008*, and will be available to be read through serial communication.

ACQUISITIONS SCREEN

Parameters related to how and when readings take place are defined in this screen. Acquisition is the operation of reading and registering in local memory the process variables (temperature, pressure etc) present in the input channels enabled. Among parameters are acquisitions start and end of readings and time interval between acquisitions.

In models without local memory, aimed only at measuring and making them available in the supervisory software, this screen will not be enabled. The acquisition screen parameters are:

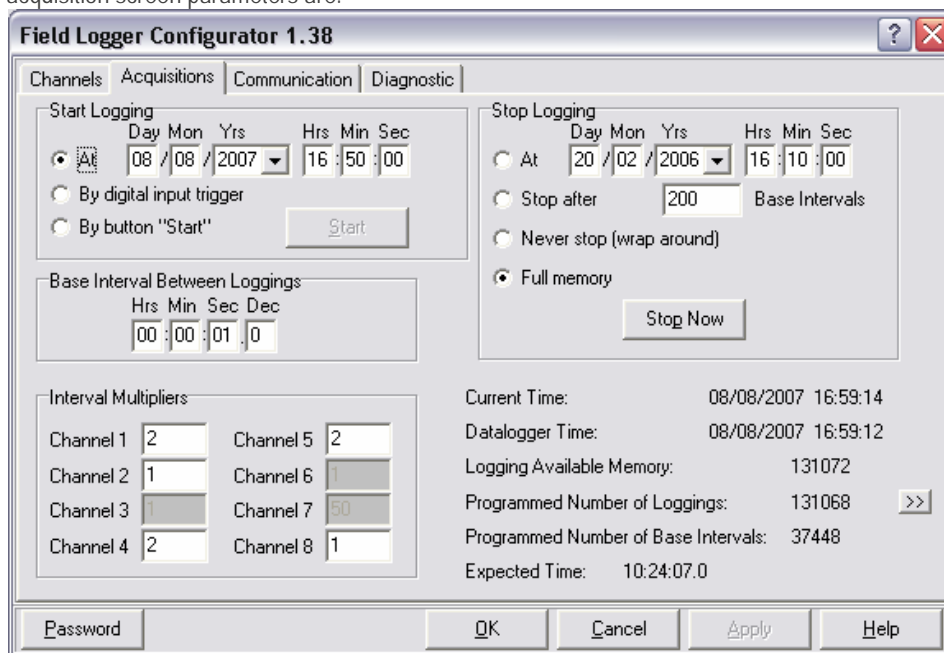

Figure 3 – Acquisitions screen

Acquisitions start – There are 3 options to start acquisitions in the logger:

1. Specific date and time. Day, month, year, hour, minutes and seconds are defined. When they are reached they start reading signals from the input channels of the logger.
2. Digital input (DI) activation. In this mode, acquisitions start whenever the DI is triggered and stop when it is disabled.
3. Through **Start** button – Determines that acquisitions start when the **Start** button is pushed from the screen. In this option, observe that settings must be already configured and applied to the logger.

Base Interval Between Loggings – Defines the minimum time interval between acquisitions. It can be from hours up to tenths of seconds and it is common to all channels. However, a multiplier of the base interval can be defined for each active channel.

Interval multiplier – Readings can be taken in different times for each channel, a base interval multiplier is defined for each channel. The multiplier can be defined between 1 and 255.

Example: For a base interval of 10s, the logger will record at every 10s the value measured in channels programmed with multiplier equals 1. At every 20s in channels with multiplier equals 2,...

Acquisition end – Defines the acquisitions end. Options are:

1. Specific date and time. Day, month, year, hour, minutes and seconds are defined. When they are reached they stop acquiring values from the input channels of the logger.
Note: Acquisitions can be stopped before the preset period is reached by pressing the **Stop Now** button or when the full memory capacity is reached.
2. Stop after a defined number of base intervals is reached.
Note: Acquisitions can be stopped before the expected acquisitions number is reached by pressing the **Stop Now** button or when the full memory capacity is reached.
3. Never stop (wrap around). Acquisitions are taken continuously. When the full memory capacity is reached, older information are replaced by new ones. The process is only interrupted if the **Stop Now** button is pressed.

FieldLogger with 128k Memory

4. Full memory. Acquisitions end when the full memory capacity is reached. Pressing the **Stop Now** button also ends acquisitions.

The Acquisitions screen has also an important group of information about the logger and acquisitions:

Current Time: Displays current date and time used by the computer.

Logger Time: Displays current date and time used by the logger.

Logging Available Memory: Displays the total memory capacity for the logger.

Programmed Number of Acquisitions: Indicates the number of acquisitions that will be performed and logged in memory. It is also possible to check the number of acquisitions per channel enabled.

Programmed Number of Base Intervals: Informs the minimum interval between programmed acquisitions

Estimated time: Informs time required to complete the programmed acquisitions.

After setting up the logger and estimating possible implications, the user must send the configuration to the logger. Press **Apply**.

To send and leave the configurator software, press **OK**. To leave the configuration without sending to the logger, press **Cancel**.

Note: When the new configuration is sent, the logger time is updated, adopting the computer time (date and hour).

COMMUNICATION SCREEN

This screen is showed even when there is no communication between logger and computer. It provides parameters related to system communication. Its fields are:

Host Parameters (HP) – Provides a choice for the serial communication port to be used.

Network Operation – Makes possible to define a new communication address and baud rate for the logger. Define values and press **Change**. If connected, it makes possible to read the complete configuration of a given logger. It is only necessary to select the required address and press **Read Configurations**. The configurator starts to display the selected logger configuration on the screen.

Parity – Makes possible to define parity used in serial communication. The number of **Stop Bits** as recommended by the Modbus standard depends on parity. When parity is configured as none, 2 stop bits are used; when parity is configured as Odd or Even, 1 stop bit is used.

Note: Baud rate and parity must be the same for all the network elements.

Automatic Search – Makes possible to search the connected logger communication parameters, in a point-to-point communication, testing all possibilities of addresses and possible transmission rates (baud rate). After the parameters are found, they are displayed.

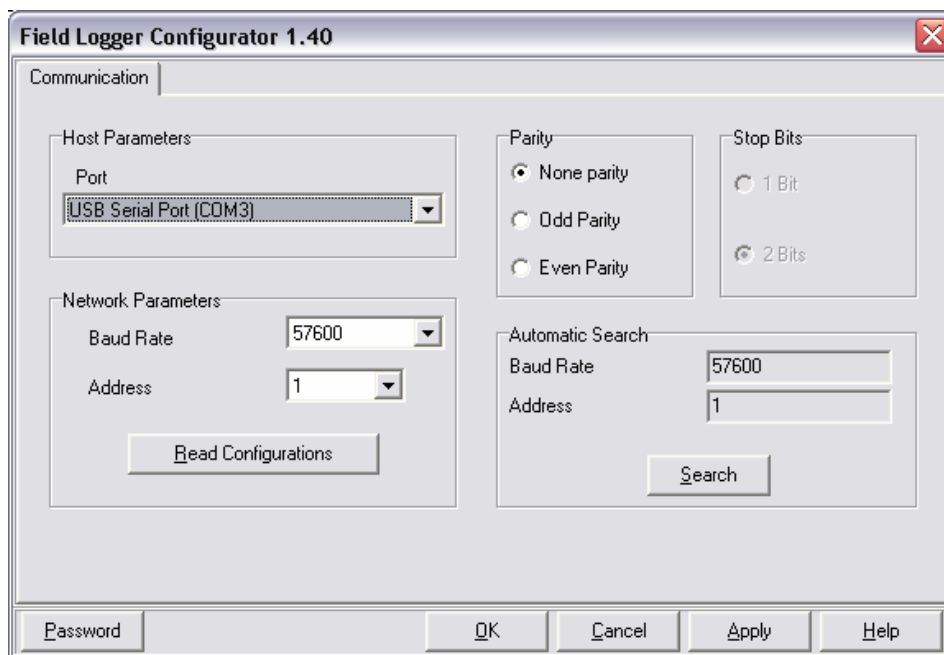

Figure 4 – Communication screen

INSTRUCTION MANUAL

FieldLogger with 128k Memory



DIAGNOSTIC PAGE

In this screen, the user visualizes how measured variables behave. Channels are presented with values measured (updated at every second), names, units, status and alarms triggered.

Information about the logger such as serial number, version and operation status are also displayed.

It is possible to apply digital filters to input channels using this screen. These filters are intended to reduce oscillations in readings. Intensity can be adjusted from 0 to 9 and the factory set is level 3. It is also possible to display the local power supply frequency so that derivative oscillations are minimized.

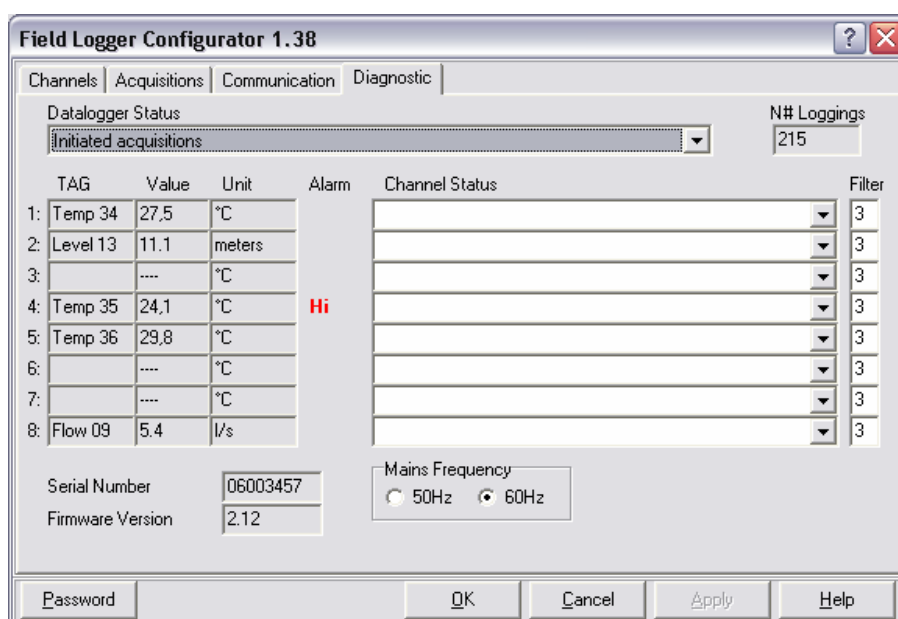

Figure 5 – Diagnostic screen

INSTRUCTION MANUAL



FieldLogger with 128k Memory

9.5 INSTALLATION

The logger has two terminal lines for input connections, power supply, backup power supply (VBAT), digital input and serial communication.

INSTALLATION RECOMMENDATIONS

- Input signal leads must be installed in grounded conduits and away from power or contactor wires.
- Instruments must be powered only by an exclusive power supply.
- Installing RC filters (47W and 100nF, serial) is strongly recommended at contactor coils or any other inductors.
- System failure should always be taken into account when designing a control panel to avoid irreversible damage to equipment or people. The ALM1 and ALM2 output relays, used as alarms, do not warrant total protection.
- Wires section: minimum gauge 0.14 mm².

Electrical Connections – Inputs

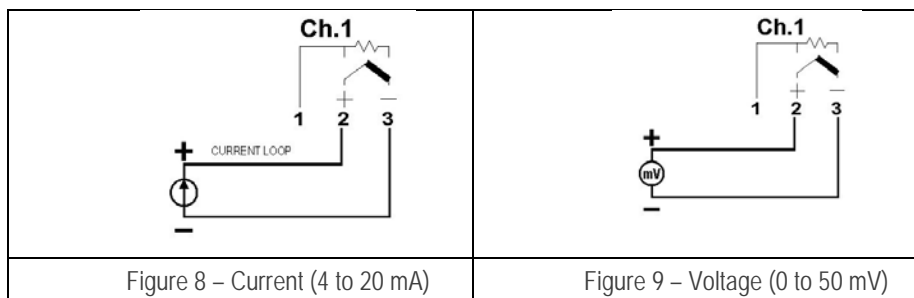
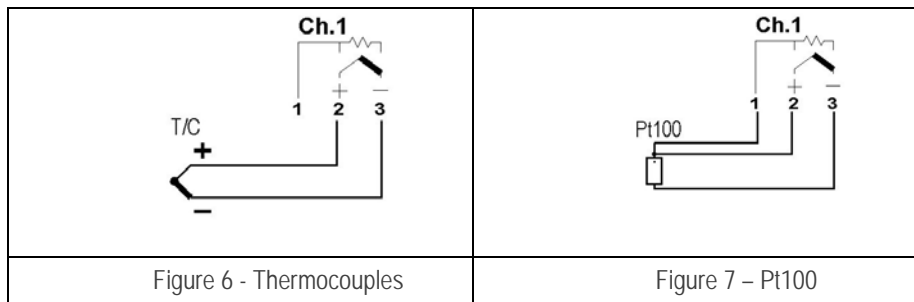

INSTRUCTION MANUAL

FieldLogger with 128k Memory



ELECTRICAL CONNECTIONS – POWER SUPPLY

Terminals 19 and 20 identified with **POWER** show the main power supply of the logger. As a backup power supply, in VBAT, terminals 14 and 15, an extra power supply of +6 to +24 VDC can be connected so that the device can continue measuring and logging operations in the failure of a main power supply.

While using the VBAT supply the logger can not use the serial communication and does not trigger ALM1 and ALM2 outputs.

ELECTRICAL CONNECTIONS – ALARMS AND DIGITAL INPUT

ALM1 and ALM2 outputs, terminals 21, 22, 23 and 24, correspond to relays used by alarms. NA contacts are available, with load capacity of 3 A / 250 V.

A dry contact device should be used (switch, relay etc) in digital inputs, terminals 13 and 14. When the contact is closed, the digital input is triggered.

Notice that when a digital input terminal is common to the VBAT negative it can be concurrently used to both ends.

D nea.	D	GND	V-Bat +	Dig. In		Ch. 4			Ch.3			Ch. 2			Ch. 1			
8	7	6	5	4	3	2	1	0										
8-KanalDatenlogger																		
9	0	1	2	3	4	5	6	7		8	9	0	1	2	3	4	5	6
Po wer		Alar m 1		Alar m 2		Ch. 5				Ch. 6			Ch. 7			Ch. 8		

Figure 10 - terminal lay-out

INSTRUCTION MANUAL

FieldLogger with 128k Memory



10. OPERATION

After configuration and installation the logger is ready to use. When you turn on the logger, the LOGGING indicator flashes in the front panel, this indicates that the logger is operating properly. It will flash once at every 2 seconds when it is not logging and twice at every two seconds when logging. Acquisitions start and end according to what was defined during configuration. The speed of input channels readings depends on the number of channels enabled and type of input programmed for each channel.

The logger starts readings immediately after it is turned on. Current values found are temporarily stored in internal registers. The logger sends the content of its internal registers when the supervisory software requires.

In the front panel there are two indicators that show when the logger is communicating with the external world. When the **Rx** indicator is turned on, it means that the device is receiving data; the **Tx** indicator shows that data are sent outside through serial interface.

ACQUIRED DATA COLLECTION

For the collection of data logged in local memory, it is necessary to use **FieldChart** or **Superview** software, or to build an application in a supervisory software whose version supports the specific driver.

10.1 SERIAL COMMUNICATION

The logger has a master-slave asynchronous serial communication interface RS485 to communicate with a supervisory computer (master). The logger is always the slave.

Communication always start with the master, which sends a command to the slave address with whom it wants to communicate. The addressed slave undertakes the command and sends the corresponding answer to the master.

The logger also accepts broadcast commands.

Note: Recommended cables for serial communication are 3 x 24 AWG (3 x 0,25mm²)+ shield. This way the shield can be grounded while cables are used for signals.

INSTRUCTION MANUAL

FieldLogger with 128k Memory



FEATURES

Signals supported by RS485 standard. We recommend reading the document "Basic concepts of RS485 and RS422" available in the CD that is delivered with the equipment.

Communication signals are electrically isolated from the rest of the device, with configurable speed of 1200, 2400, 4800, 9600, 19200 and 57600 bps.

Number of data bits: 8.

Parity: none, odd or even.

Number of stop bits: 1 (odd or even parity) or 2 (no parity).

Response delay: up to 20 ms after command is received.

Protocol: Modbus RTU, available in most supervisory software of the industry.

RS-485 signals are:

D1	D	D+	B	Bidirectional Data Line	Terminal 17
D0	D:	D-	A	Reserved Bidirectional Data line	Terminal 18
C			GND	Optional Connection that enhances the Communication Performance	Terminal 16
GND					

PHYSICAL SPECIFICATIONS

- Three-wire connection (2 data wires and 1 common) between 1 master and up to 247 instruments (maximum of 31 per network segment) in bus topology.
- Shielded cable, 3 x 24 AWG (3 x 0,25mm²), with shield grounded in one end;
- 16 pF capacitance at every 30 m;
- Typical impedance: 120 Ohms;
- Maximum length 1200 m;

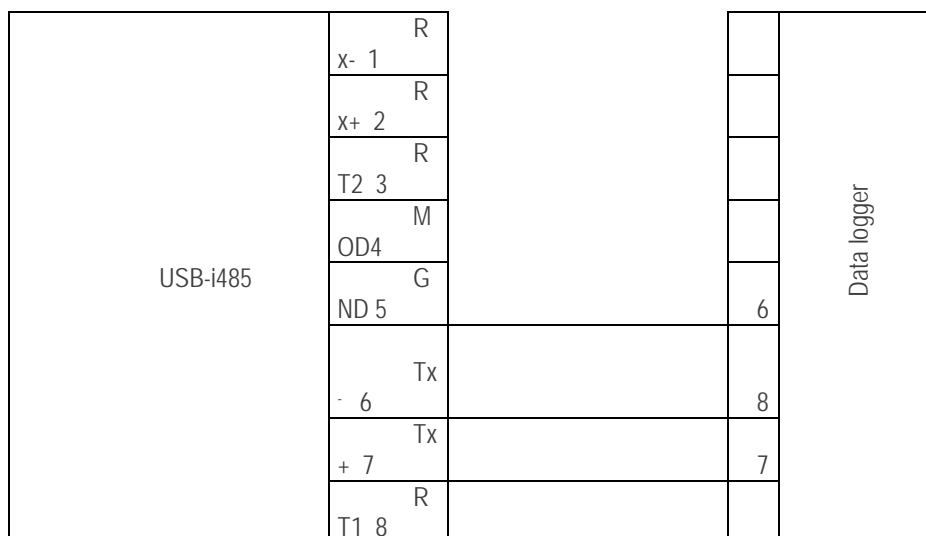

INSTRUCTION MANUAL

FieldLogger with 128k Memory



10.2 REGISTERS

The logger configurable parameters are organized in a Table of Registers. The block reading command makes possible to read multiple registers with the same request.

The configuration software, however, makes such table not necessary, once it reads and writes in all registers that require configuration. Each parameter in the table is a word of 16 bits.

The available Modbus command for the reading operation is the following:

HOLDING REGISTERS	DESCRIPTION	HOLDING REGISTERS	DESCRIPTION
0000	Current Value of Channel 1	0101	Bytes 2 and 3 of Channel 5 String (tag)
0001	Current Value of Channel 2	0102	Bytes 4 and 5 of Channel 5 String (tag)
0002	Current Value of Channel 3	0103	Bytes 6 and 7 of Channel 5 String (tag)
0003	Current Value of Channel 4	0104	Bytes 0 and 1 of Channel 6 String (tag)
0004	Current Value of Channel 5	0105	Bytes 2 and 3 of Channel 6 String (tag)
0005	Current Value of Channel 6	0106	Bytes 4 and 5 of Channel 6 String (tag)
0006	Current Value of Channel 7	0107	Bytes 6 and 7 of Channel 6 String (tag)
0007	Current Value of Channel 8	0108	Bytes 0 and 1 of Channel 7 String (tag)
0008	Informs Alarm Status	0109	Bytes 2 and 3 of Channel 7 String (tag)
0009	Reserved: Inform General Status	0110	Bytes 4 and 5 of Channel 7 String (tag)
0010	Informs Channel 1 and 2 Status	0111	Bytes 6 and 7 of Channel 7 String (tag)
0011	Informs Channel 3 and 4 Status	0112	Bytes 0 and 1 of Channel 8 String (tag)
0012	Informs Channel 5 and 6 Status	0113	Bytes 2 and 3 of Channel 8 String (tag)
0013	Informs Channel 7 and 8 Status	0114	Bytes 4 and 5 of Channel 8 String (tag)
0014	Current Time (seconds and minute)	0115	Bytes 6 and 7 of Channel 8 String (tag)
0015	Current Time (hour and day)	0116	Bytes 0 and 1 of the Engineering Unit of Channel 1
0016	Current Time (month and year)	0117	Bytes 2 and 3 of the Engineering Unit of Channel 1
0017	Channel 1 Configuration	0118	Bytes 4 and 5 of the Engineering Unit of Channel 1
0018	Channel 2 Configuration	0119	Bytes 6 and 7 of the Engineering Unit of Channel 1
0019	Channel 3 Configuration	0120	Bytes 0 and 1 of the Engineering Unit of Channel 2
0020	Channel 4 Configuration	0121	Bytes 2 and 3 of the Engineering Unit of Channel 2
0021	Channel 5 Configuration	0122	Bytes 4 and 5 of the Engineering Unit of Channel 2
0022	Channel 6 Configuration	0123	Bytes 6 and 7 of the Engineering Unit of Channel 2
0023	Channel 7 Configuration	0124	Bytes 0 and 1 of the Engineering Unit of Channel 3
0024	Channel 8 Configuration	0125	Bytes 2 and 3 of the Engineering Unit of Channel 3
0076	Bytes 0 and 1 of the Title String	0126	Bytes 4 and 5 of the Engineering Unit of Channel 3
0077	Bytes 2 and 3 of the Title String	0127	Bytes 6 and 7 of the Engineering Unit of Channel 3

INSTRUCTION MANUAL

FieldLogger with 128k Memory



0078	Bytes 4 and 5 of the Title String	0128	Bytes 0 and 1 of the Engineering Unit of Channel 4
0079	Bytes 6 and 7 of the Title String	0129	Bytes 2 and 3 of the Engineering Unit of Channel 4
0080	Bytes 8 and 9 of the Title String	0130	Bytes 4 and 5 of the Engineering Unit of Channel 4
0081	Bytes 10 and 11 of the Title String	0131	Bytes 6 and 7 of the Engineering Unit of Channel 4
0082	Bytes 12 and 13 of the Title String	0132	Bytes 0 and 1 of the Engineering Unit of Channel 5
0083	Bytes 14 and 15 of the Title String	0133	Bytes 2 and 3 of the Engineering Unit of Channel 5
0084	Bytes 0 and 1 of Channel 1 String (tag)	0134	Bytes 4 and 5 of the Engineering Unit of Channel 5
0085	Bytes 2 and 3 of Channel 1 String (tag)	0135	Bytes 6 and 7 of the Engineering Unit of Channel 5
0086	Bytes 4 and 5 of Channel 1 String (tag)	0136	Bytes 0 and 1 of the Engineering Unit of Channel 6
0087	Bytes 6 and 7 of Channel 1 String (tag)	0137	Bytes 2 and 3 of the Engineering Unit of Channel 6
0088	Bytes 0 and 1 of Channel 2 String (tag)	0138	Bytes 4 and 5 of the Engineering Unit of Channel 6
0089	Bytes 2 and 3 of Channel 2 String (tag)	0139	Bytes 6 and 7 of the Engineering Unit of Channel 6
0090	Bytes 4 and 5 of Channel 2 String (tag)	0140	Bytes 0 and 1 of the Engineering Unit of Channel 7
0091	Bytes 6 and 7 of Channel 2 String (tag)	0141	Bytes 2 and 3 of the Engineering Unit of Channel 7
0092	Bytes 0 and 1 of Channel 3 String (tag)	0142	Bytes 4 and 5 of the Engineering Unit of Channel 7
0093	Bytes 2 and 3 of Channel 3 String (tag)	0143	Bytes 6 and 7 of the Engineering Unit of Channel 7
0094	Bytes 4 and 5 of Channel 3 String (tag)	0144	Bytes 0 and 1 of the Engineering Unit of Channel 8
0095	Bytes 6 and 7 of Channel 3 String (tag)	0145	Bytes 2 and 3 of the Engineering Unit of Channel 8
0096	Bytes 0 and 1 of Channel 4 String (tag)	0146	Bytes 4 and 5 of the Engineering Unit of Channel 8
0097	Bytes 2 and 3 of Channel 4 String (tag)	0147	Bytes 6 and 7 of the Engineering Unit of Channel 8
0098	Bytes 4 and 5 of Channel 4 String (tag)	0152	Decimal Point Position for Channels
0099	Bytes 6 and 7 of Channel 4 String (tag)	0199	Software Version
0100	Bytes 0 and 1 of Channel 5 String (tag)		

INSTRUCTION MANUAL

FieldLogger with 128k Memory



NOTES ABOUT REGISTERS

Registers 00 to 07:

They keep the continuously updated value of readings from their respective input channels. The speed of such update depends on the number of channels enabled and the input type selected for such channels. As the register is constantly scanning inputs, the higher the number of active channels the higher the number of inputs that will be read until the device reads the same channel again, decreasing the update speed. Besides, channels configured as Pt100 are read twice each, as part of a compensation algorithm of the cable resistance. In cases where there is only one active channel (no defined as Pt100), this channel is updated at every 0.2 seconds (best rate). In the case of eight Pt100 channels (worst rate), complete scanning of channels takes 0.95 seconds.

The signal of the value read is represented as complement of 2.

In cases with resolutions in tenth of degrees, such as Pt100 and thermocouples, the value is read without the decimal point (multiplied by 10), for protocol constraints. The same way, the decimal point is disregarded in linear inputs (4-20 mA e 0-50 mV).

Register 08:

Reports if there is an alarm event in some of the channels and if the event corresponds to a Low or High alarm.

Byte High:

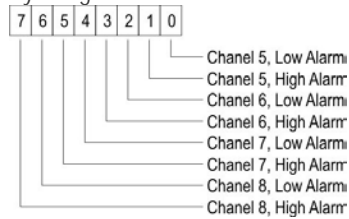

Byte Low:

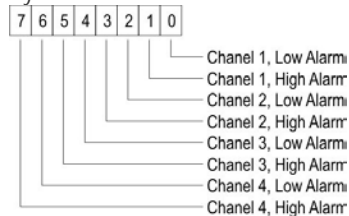

Registers 10 to 13

Report A/D conversion errors.

byte high -> odd channel:

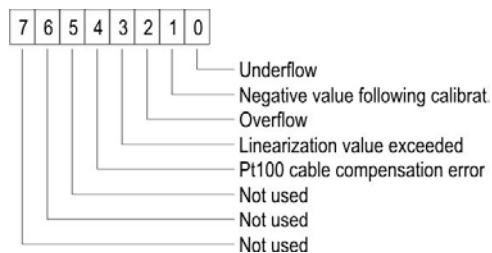

byte low ® even channel:

Same as byte high for the adjacent channel.

INSTRUCTION MANUAL



FieldLogger with 128k Memory

Registers 14 to 16

Only valid when FieldLogger has a real-time clock (model with memory)

byte high: Second (Reg. 14), hour (Reg. 15) or month (Reg. 16) device currencies.

byte low: Minute (Reg. 14), day (Reg. 15) or year (Reg. 16) device currencies. Year is always based on the number 1998. Thus, if the value logged is 9, in fact the current year is (1998 + 9 =) 2007.

Registers 17 to 24:

Deal with the current configuration of their respective channels, more specifically about the type of input, engineering unit for temperature sensors (Pt100 and thermocouple), channel acquisitions enablement, option of differential input (sensor between two inputs) and type of alarm triggering.

byte high:

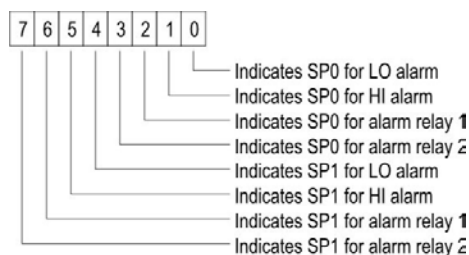

Byte low:

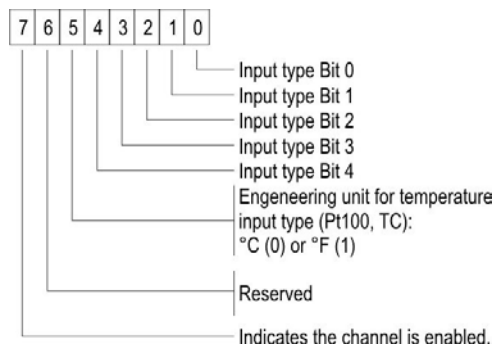

INSTRUCTION MANUAL

FieldLogger with 128k Memory



INPUT TYPE	Code	MEASUREMENT RANGE
Thermocouple J	0	-50.0 to 760.0°C (-58.0 to 1400.0°F)
Thermocouple K	1	-90.0 to 1370.0°C (-130.0 to 2498.0°F)
Thermocouple T	2	-100.0 to 400.0°C (-148.0 to 752.0°F)
Thermocouple E	3	-35.0 to 720.0°C (-31.0 to 1328.0°F)
Thermocouple N	4	-90.0 to 1300.0°C (-130.0 to 2372.0°F)
Thermocouple R	5	0.0 to 1760.0°C (-32.0 to 3200.0°F)
Thermocouple S	6	0.0 to 1760.0°C (-32.0 to 3200.0°F)
Thermocouple B	7	150.0 to 1820.0°C (302.0 to 3308.0°F)
Pf100	8	-200.0 to 530.0°C (-328.0 to 986.0°F)
4 – 20 mA Lin. J	9	Thermocouple J curve, -50.0 to 760.0°C
4 – 20 mA Lin. K	10	Thermocouple K curve, -90.0 to 1370.0°C
4 – 20 mA Lin. T	11	Thermocouple T curve, -100.0 to 400.0°C
4 – 20 mA Lin. E	12	Thermocouple E curve, -35.0 to 720.0°C
4 – 20 mA Lin. N	13	Thermocouple N curve, -90.0 to 1300.0°C
4 – 20 mA Lin. R	14	Thermocouple R curve, 0.0 to 1760.0°C
4 – 20 mA Lin. S	15	Thermocouple S curve, 0.0 to 1760.0°C
4 – 20 mA Lin. B	16	Thermocouple B curve, 150.0 to 1820.0°C
4 – 20 mA Lin. Pt100	17	Pt100 curve, -200.0 to 530.0°C
4 – 20 mA Linear	18	Programmable indication range from -1999 to 9999
0 – 50 mV Linear	19	Programmable indication range from -1999 to 9999

Registers 76 to 147:

Contain bytes with ASCII characters of the general title, individual tags of each channel and respective engineering units.

Register 152:

Reports the decimal point position of channels configured as linear inputs. At every two bits there is the information about a channel:

- 00 no decimal point
- 01 one decimal point
- 10 two decimal points
- 11 three decimal points

byte high:

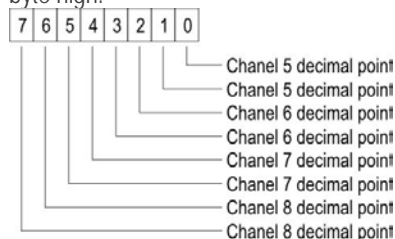

byte high:

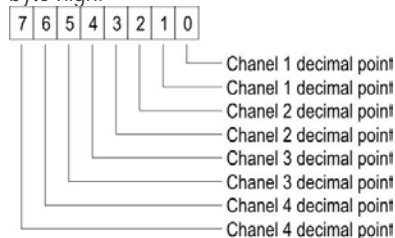

INSTRUCTION MANUAL

FieldLogger with 128k Memory



TRIGGERING DIGITAL OUTPUTS

The Modbus command available to enable and disable outputs (provided they are configured as digital outputs) is the following:
05 – *Preset Single Coil* (Writes in Digital Outputs)

The ALM1 output corresponds to the output point address 0. The ALM2 output corresponds to the output point address 1.

COMMUNICATION FAULT

In case there is any communication issue with the device, please check the following items:

- Is the device correctly energized?
- Is the serial cable tightly connected? In negative case, connect it in the appropriate form.
- In Configurator, the communication port selected corresponds to the port to which the register is connected? In case it does not match the right port, select the correct one.
- Is there any other software using the required communication port in the computer? In positive case, close the software and try to communicate again.

If none of the above steps manage to solve the problem try to:

- Run the "Automatic Search" option, and check if there is not more than one register connected to the network.
- Use other serial port from PC.
- Install the Configurator in another PC and try to repeat the steps indicated above

INSTRUCTION MANUAL

FieldLogger with 128k Memory



11. TECHNICAL DATA

General Technical Data	
Signal Input:	Configurable according to Table 01. Eight (8) channels: CH1, CH2, CH3, CH4, CH5, CH6, CH7 and CH8 Note: All thermocouples are linearized through software and cold junction compensation. NBR 12771 calibrated thermocouples, NBR 13773 Pt100.
Accuracy:	J, K, T, E, N: 0.2 % of the max. range ± 1 °C R, S and B: 0.25 % of the max. range ± 3 °C; Pt100: 0.2 % of the max. range
Input Impedance:	4-20 mA and 0-50 mV: 0.2 % of the max. range
Pt100 Measurements:	Thermocouples/Pt100/0-50 mV: >1 MW, 4-20 mA: 33 W + 1.5 V 3-wire circuit with excitation current of 0.17mA and cable-resistance compensation. Note: When using Pt100 calibrators to gauge the meter, check if the required excitation current is compatible with the register current
Internal Resolution:	20,000 levels (>14 bits)
Log Capacity:	131072 (128 k) logs
Sampling Rate:	From 550 ms to 950 ms for eight channels
Outputs (ALM1 and ALM2):	SPST-NA 3 A / 250 V (3 A / 30 VDC)
Power Supply:	100 to 240 VAC/DC, 50/60 Hz, Optional 24 VAC/DC, Max. Consumption: 2 VA
Secondary Supply (V_{BAT}):	Voltage: from +6 to 24 V, Consumption: < 50 mA
Operating Conditions:	Operating Temperature: 5 to 50 °C Relative humidity: 80% to 31°C, linear fall of 50% to 40 °C; Internal, use; Installation Category II, Pollution Degree 2; altitude $< 2,000$ m
Dimensions:	105 x 90 x 60 mm
Protection Class:	IP30
Housing:	ABS case
Data Connection:	Standard serial communication RS485 MODBUS-RTU
FieldLogger with 128k 230VAC 0568 0040	FieldLogger, 8 Channel Universal Input Data Logger and RTU, with 128k Internal Recording Memory 230VAC power supply
FieldLogger with 128K 24VDC 0568 0040-01	FieldLogger, 8 Channel Universal Input Data Logger and RTU, with 128k Internal Recording Memory and 24VDC power supply
USB – i458 Converter 0568 0040-10	USB Converter to Dual RS485 Isolated Ports
ISO485-2 – RS485 / 232 Converter 0568 0040-11	RS485 / 232 Dual Isolated Converter with Power Supply

INSTRUCTION MANUAL

FieldLogger with 128k Memory



12. GENERAL QUESTIONS

If you have any questions concerning this product of B+B Thermo-Technik GmbH, please do not hesitate to contact us at:

B+B Thermo-Technik GmbH
Heinrich-Hertz-Straße 4
78166 Donaueschingen
Germany

Tel.: +49 771 83160
Fax: +49 771 831650

E-Mail: info@bb-sensors.com
www.bb-sensors.com

We wish you a successful measuring!

Your Temperature-Partner
B+B Thermo-Technik GmbH

All technical information in this document are proved by us with high accuracy and shall inform you about all application possibilities. This information's are not confirmed by us and need to be proved by every user in regard to his intended use of the equipment. All foreign trade mark rights need to be considered.